



SOCIETY FOR INDUSTRIAL ARCHEOLOGY

NEWSLETTER

Volume 34

Spring 2005

Number 2

ORUKTER AMPHIBOLOS

Oliver Evans SIA Chapter Plans Celebration of 200th Anniversary of the First Motorized Carriage

In July 1805, a strange vehicle made its way down Philadelphia's Market Street to the Schuylkill River. This was the *Orukter Amphibolos*, a steam-powered amphibious dredge invented by Oliver Evans. The vehicle, widely regarded as the first motorized, wheeled vehicle to travel a public street in the United States, was a major mechanical engineering achievement. The Oliver Evans SIA Chapter will celebrate the 200th anniversary on July 16 with a parade and reenactment. The event will be co-sponsored by the city's water and health departments.

The Philadelphia Board of Health commissioned the

Orukter Amphibolos in 1805 for its fight against water pollution that contributed to disease. The board desired a dredge to bring up debris and waste from around the city's docks. Oliver Evans was an inventor and manufacturer with a workshop at 9th and Market Streets. He is most often remembered for his automation of flour milling, for his book *The Young Millwright and Miller's Guide* that served as the textbook for millers from its publication in 1795 to the 1880s, and for his invention of the high-pressure steam engine that became the basic power employed in mills and factories as the industrial revolution took hold in the early 19th century.

(continued on page 2)

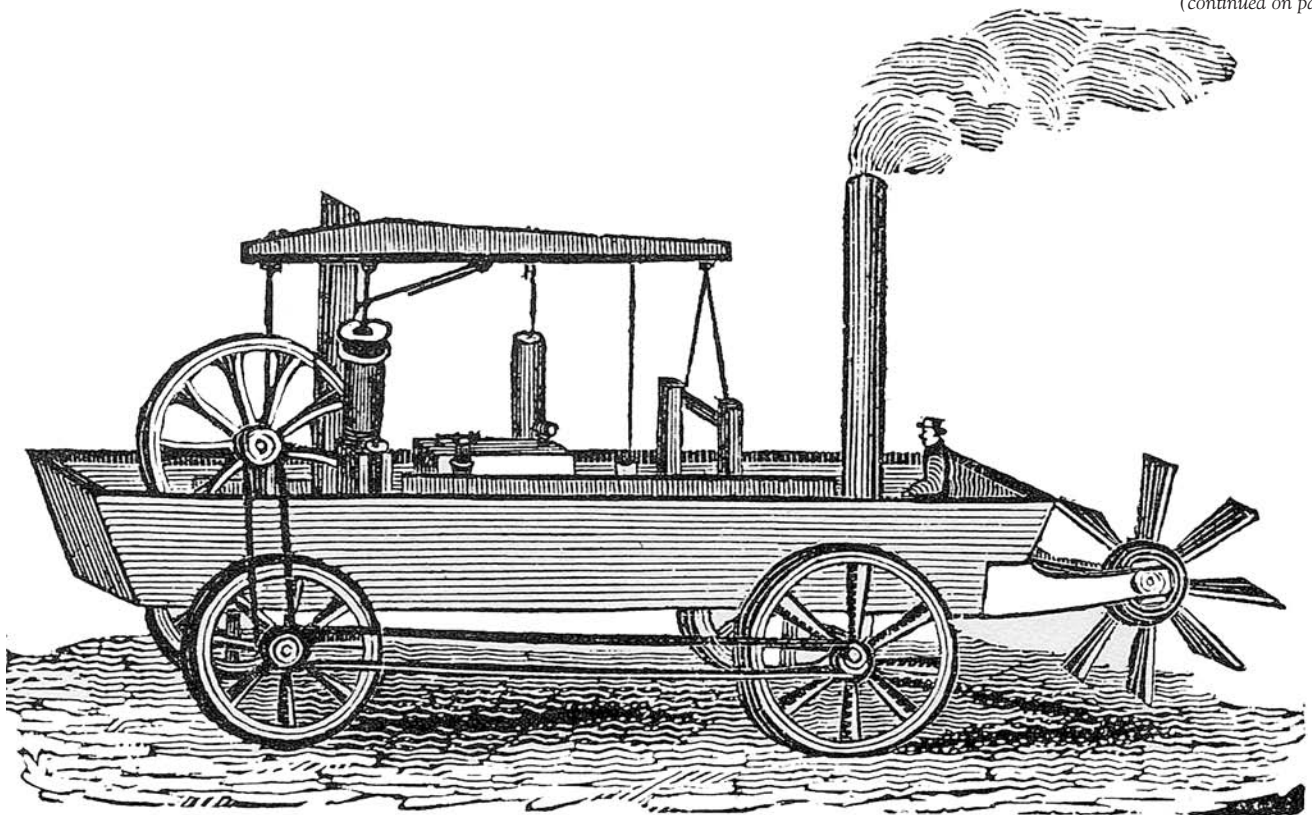

Orukter Amphibolos. A conjectural view from *The Mechanic* (Boston, 1834) as reprinted in Eugene S. Ferguson, *Oliver Evans* (1980), p. 40. Evans left no original plans or drawings of the vehicle, although he did leave some notes and a plan for a steam wagon of about the same date, providing some idea of how the *Orukter Amphibolos* may have been propelled.



Oliver Evans. From *Appleton's Dictionary of Machines, Mechanics, Engine-Work, and Engineering* (1867).

The *Orukter Amphibolos* was a scow in which Evans placed a high-pressure steam engine and dredging equipment. Utilizing a principle he had previously developed to move grain and flour in mills, the *Orukter Amphibolos* employed a chain of buckets to bring up muck from the harbor to be hauled away by another boat. (Orukter is derived from the Greek word for digger.) Evans had to deliver the 17-ton *Orukter Amphibolos* from his workshop to the river. He placed wheels under it and

used steam power to propel it, no mean accomplishment.

In mid July 1805, Philadelphia newspapers reported that the *Orukter Amphibolos* traveled Market Street to Centre Square, the location of the first Philadelphia Water Works and of City Hall today. The vehicle then circled the square for several days so that onlookers could view this unusual sight, contributing 25 cents each to help defray the excessive cost. Finally, the *Orukter Amphibolos* steamed to the banks of the Schuylkill River where it floated on a rising tide and was lifted off its wheels. After Evans had added a paddlewheel at the stern, the *Orukter Amphibolos* steamed down the

The *SIA Newsletter* is published quarterly by the Society for Industrial Archeology. It is sent to SIA members, who also receive the Society's journal, *IA*, published biannually. The SIA through its publications, conferences, tours, and projects encourages the study, interpretation, and preservation of historically significant industrial sites, structures, artifacts, and technology. By providing a forum for the discussion and exchange of information, the Society advances an awareness and appreciation of the value of preserving our industrial heritage. Annual membership: individual \$35; couple \$40; full-time student \$20; institutional \$50; contributing \$75; sustaining \$125; corporate \$500. For members outside of North America, add \$10 surface-mailing fee. Send check or money order payable in U.S. funds to the Society for Industrial Archeology to SIA-HQ, Dept. of Social Sciences, Michigan Technological University, 1400 Townsend Drive, Houghton, MI 49931-1295; (906) 487-1889; e-mail: SIA@mtu.edu; Web site: www.sia-web.org.

Mailing date for Vol. 34, 2 (Spring 2005), June 2005. If you have not received an issue, apply to SIA-HQ (address above) for a replacement copy.

The *SIA Newsletter* welcomes material and correspondence from members, especially in the form of copy already digested and written! The usefulness and timeliness of the newsletter depends on you, the reader, as an important source of information and opinion.

TO CONTACT THE EDITOR: Patrick Harshbarger, Editor, *SIA Newsletter*, 305 Rodman Road, Wilmington, DE 19809; (302) 764-7464; e-mail: phsianews@aol.com.

Schuylkill and around Girard Point before steaming up the Delaware River to the Market Street docks. There the Board of Health took possession. "It is not known how effective the dredge was, but city records indicate the continuous need for further work and repairs until it was sold for scrap in 1809."

On July 16, the Oliver Evans SIA Chapter plans to take part in a reenactment of the *Orukter Amphibolos's* journey by traveling in a parade of "ducks"—amphibious army vehicles used for tourism. The ducks will circle City Hall and then proceed to the Delaware River to meet the water department's new skimmer, a boat designed to remove debris from the top of the water, continuing the work begun two centuries ago." SIA members will be on hand to explain the history of the *Orukter Amphibolos* and Oliver Evans to the media and public. Info: Jane Mork Gibson, 610-279-6075.

Jane Mork Gibson & Patrick Harshbarger

In Evans's Own Words

I constructed for the Board of Health of Philadelphia a machine for cleaning docks, called the *Orukter Amphibolos* or Amphibious Digger. It consisted of a heavy flat bottomed boat, 30 feet long and 12 feet broad, with a chain of buckets to bring up the mud, and hooks to clear away sticks, stones, and other obstacles. These buckets are wrought by a small steam engine set in the boat, the cylinder of which is 5 inches diameter and the length of stroke 19 inches. This machine was constructed at my shop, 1½ miles from the river Schuylkill where she was launched. She sunk 19 inches, displacing 551 cubic feet of water, which at 62.5 pounds, the weight of a cubic foot, gives the weight of the boat 34,437 pounds, which divided by 213, the weight of a barrel of flour, gives the weight of 161 barrels of flour that the boat and engine is equal to. Add to this the heavy pieces of timber and wheels used in transporting her, and the number of persons generally in her, will make the whole burden equal to at least 200 barrels of flour. Yet this small engine moved so great a burden, with a gentle motion up Market-street and around the Centre Square; and we concluded from the experiment, that the engine was able to rise any ascent allowed by law on turnpike roads, which is not more than 4 degrees.

When she was launched we fixed a simple wheel at her stern to propel her through the water by the engine. Although she is square at each end and illy constructed for sailing, (excepting that she is turned up short at bottom) and drew 19 inches of water, yet we concluded that if the power had been applied to give the paddle wheel the proper motion we could have stemmed the tide of the Delaware.

—Oliver Evans, quoted in Greville and Dorothy Bathe, *Oliver Evans: A Chronicle of Early American Engineering* (Philadelphia, 1935), p. 111.

SIA Study Tour to Bologna, Nov. 2005

The Museo del Patrimonio Industriale in Bologna, Italy, has invited the SIA to participate in an international symposium on industrial archeology and museums. In conjunction with the one-day symposium, a week-long study tour will introduce us to Bologna's industrial heritage. Registrants may choose to attend one or both.

Located in the 1887 former Galotti Brickworks, the Museo documents the history of water-powered silk mills; food processing, especially meat (salami and mortadella); the fabrication of machines for packaging, cigarettes, and other forming work; and the manufacture of motorcycles and automobiles.

Proposed tour sites include the restored Lock of Casalecchio di Reno, built in 1360, which provided power for the earliest stages of industrialization by controlling the flow of the River Reno; the 1928 Art Nouveau-style Farnetta Hydroelectric Power Plant; Ducati, a maker of motorcycles that began as a manufacturer of radio equipment in 1926; the museum of Lamborghini, a company that began making tractors and has made automobiles since 1963; Sacmi in Imola that began in 1919 as a cooperative machine shop repairing steam engines and agricultural implements and became a maker of forming machinery to serve the local ceramic-tile industry after WWII; and the Barilla Center, a former pasta factory re-designed by architect Renzo Piano as a multi-purpose complex that includes a hotel, cinema, and the Academia Barilla, devoted to Italian gastronomy.

The tour is limited to 50 and will run from Sun., Nov. 20 to Sat., Nov. 26, 2005. It may be extended through Sun., Nov. 27. The date of the symposium is yet to be determined, based on availability of speakers. It is expected the attendees will travel to Bologna on their own and will pay their own airfare. The cost of the tour will be about \$1,700, including tour guide, hotel, meals, museum admission, etc. for the week. The cost of the symposium is not yet set.

More details will be provided only to those who express an interest in attending this tour. No brochure will be mailed. Updated plans will be posted at www.sia-web.org. For more info and to be placed on the notification list, please contact Mary Habstritt, SIA Events Coordinator, events@siahq.org or 212-769-4946.



The interior of the Hoffman kiln at the Galotti Brickworks in Bologna houses an exhibition showing the school workshop of Aldini Valeriani of the second half of the 19th c.

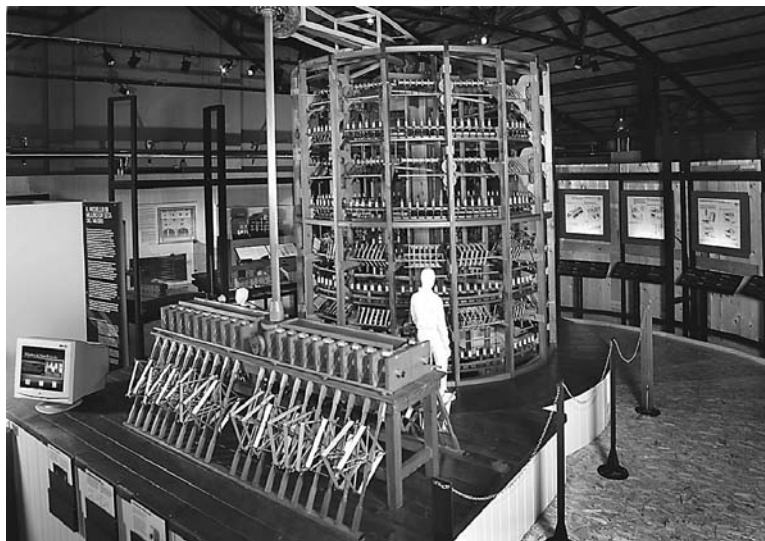

Scale model of Bologna silk mill of the 15th c.

Related Web sites:

www.comune.bologna.it/patrimonioindustriale/site/en/english.htm

www.ducati.com

www.lamborghini.com

www.galleria.ferrari.com

www.sacmi.com

IA in Wisconsin Art: The Arthur Covey Murals at Kohler

SIA members will have the opportunity to tour Kohler and see the murals during the 2005 Annual Conference—Milwaukee

In 1924, Arthur Sinclair Covey (1877-1960) painted a series of handsome murals dramatically portraying the manufacture of plumbing fixtures for the lobby of the Kohler Company's new general office building at its Wisconsin facility, an extensive operation comprised of a pottery, an iron foundry, an enamel shop, a factory for plumbing supply fittings, and another for the manufacture of engines and electrical equipment. The purpose of Covey's canvases was not just to beautify a corporate entrance hall, but also, as a company publication declared; to "depict in the work performed here daily the dignity and nobility that it surely possesses."

Covey grew up in the Midwest, and like many aspiring artists of that region received his training at the Art Institute of Chicago. From the start of his career, he was interested in mural painting, serving as an assistant to Frank Brangwyn in London, and, after his return to America in 1913, working with Robert Reid on a series of panels for the Panama-Pacific Exposition (1915) in San Francisco. The next year he received his first solo commission, painting three murals for the public library in Wichita, Kansas.

The strong regional roots of Kohler, founded in 1873, made it logical that they would choose a midwesterner for their paintings. Covey executed seven large and colorful murals (pigments range from orange to ultramarine) depicting Kohler's manufacturing processes and products. Installed on the lobby walls, they provide a dramatic entrance to the building, which also features a high arched ceiling and a broad stairway. The dedication boldly declared on one mural—"TO THE MEN WHOSE COOPERATION HAS MADE THIS ORGANIZATION THIS HALL IS DEDICATED"—conveys the commitment of the people whose efforts contributed to the success of the foundries and potteries at Kohler.

Pouring a Mold is one of the most dramatic of the Covey murals. Inscribed in block letters—"HE WHO TOILS HERE HATH SET HIS MARK"—the values implicit in the virtue of disciplined labor were ones suitable for an artist as well. Steam pours out as the factory workers, who flank either side, tip the molten iron into a sand mold to form the casting for a plumbing fixture. After pouring, the iron cooled for twenty minutes before the still-hot casting was removed from the

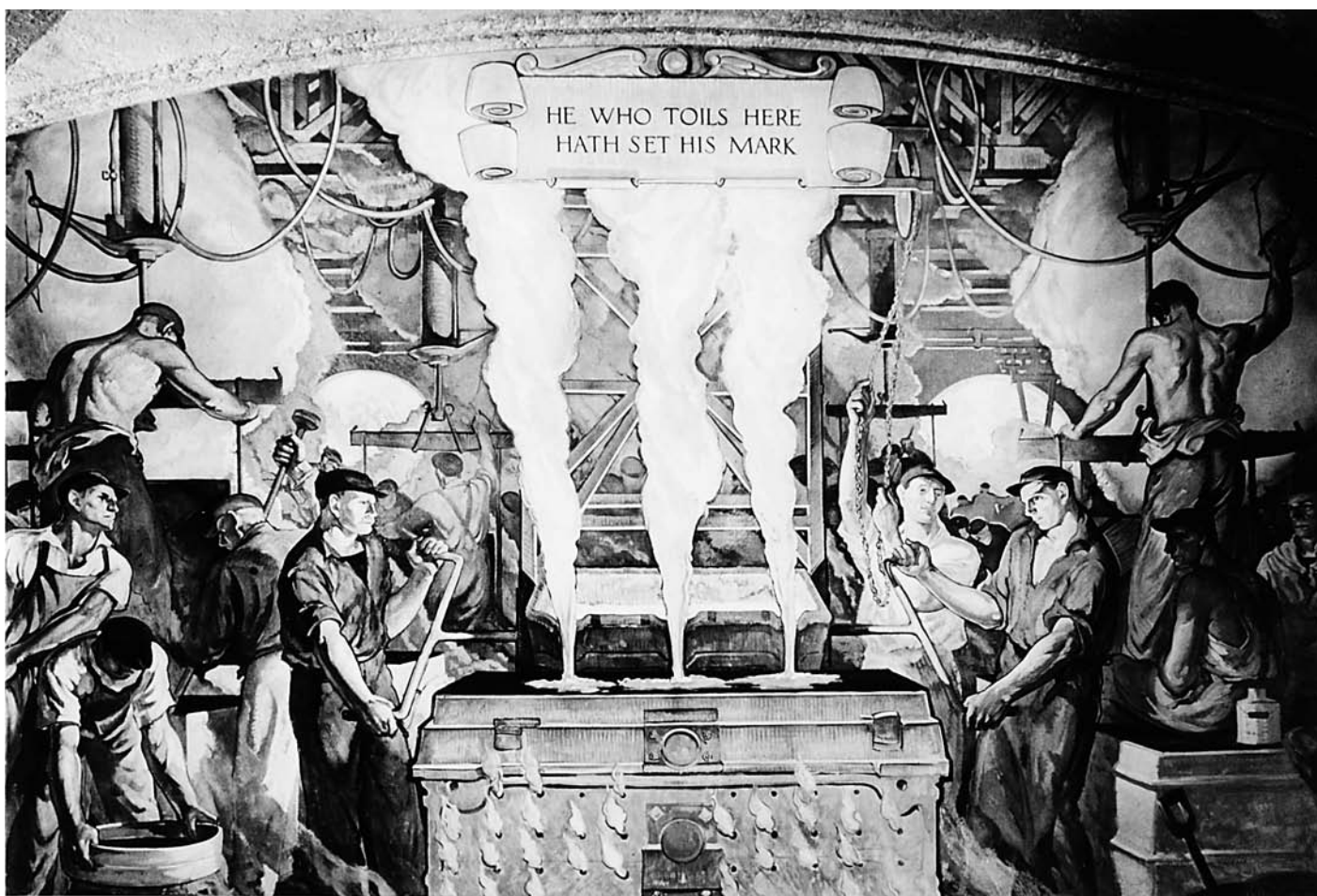

Arthur Covey, *Pouring a Mold*, 1924, oil on canvas, 12 ft. × 18 ft.-4 in., Kohler Corporation.

mold. The workmen are stripped to the waist because of the intense heat, their powerfully muscled bodies conveying a sense of the strength needed to perform their tasks, as well as the masculine character of the environment in which they work. Covey's mural celebrates labor in its most physical sense. The balanced arrangement of the figures conveys the ceremonial aspect of the carefully synchronized operation. As a company brochure stated: "It is a sort of climax and culminating point of the work in the foundry."

Tapping a Cupola presents the principal ingredients in the production of cast-iron ware (pig iron, scrap iron, coke, and limestone) deposited in the top of a towering 75-ft. cupola. After being heated to a temperature of 2700°F, the molten iron is tapped at the bottom. Covey's portrayal of the flowing metal being drawn from the furnace is visually exciting. Each man has a specific job to do, and by working in concert they collectively create a dynamic rhythm of harmonized labor.

The remaining murals depict other parts of the process. Once removed from the mold, the product passes through a cleaning device where any sand adhering to the casting is removed with steel shot. This is the subject of *The Sandblast*: "Guided by alert and brawny men, an unending stream of castings passes through the sandblast. With quick eyes and trained minds, the workers inspect each piece that passes through their hands and pronounce judgment upon it."

In *Grinding the Castings*, all burrs, jagged edges, and any unevenness are removed from the casting by high-speed grinding wheels. Although a casual observer might regard the operation as characterized by only "din and apparent confusion," underlying it all is "an admirable spirit of order and concentration of manly energies upon a formidable task."

Enameling a Bath Tub portrays a process in which "The men are tense, yet deliberate. Attention is a sharp focus. In every movement we see the deftness of the individual and the perfect harmony and rhythm of the team." After the

ground coat or bonding agent has been sprayed on the cast-iron ware in liquid form, the fixture is pre-heated in a gas-fired furnace to a temperature of 1600°F, and then transferred to an even hotter furnace. The powdered dry enamel is sifted onto the red-hot ware, fusing to the iron to form a smooth, glassy surface.

Another mural shows molten iron being poured from a large ladle into a hand ladle for the casting of smaller ware. A seventh painting portrays raw materials that have been melted in furnaces, and then discharged into tanks of cold water, crystallizing the molten mixture into a composition called "frit," which is then finely ground into enamel powder.

Studies for *Pouring a Mold* and *Tapping a Cupola* were exhibited in New York before they were installed at Kohler, winning a Gold Medal from the Architectural League of New York. One critic praised the murals for their "virility and freshness of approach," which made artistic viewers see "beauty in everyday scenes," something already apparent to the administrators in Wisconsin who had commissioned them.

The tradition established by the company's patronage of Covey continues in the Arts/Industry residency program administered by the John Michael Kohler Arts Center in Sheboygan. Artists working in ceramics, iron, and brass engage the technologies and facilities of the Kohler Company to explore new ways of thinking and working, pursuing forms and concepts not possible in their own studios. Artwork commissioned for magazine ads during the twenties and thirties is on display in a museum at the Kohler Design Center.

Betsy Fahlman

Angela Miller at the Kohler Corporate Archives assisted with the research for this article. For more on company history, see Richard Blodgett, A Sense of Higher Design: The Kohlers of Kohler (Lyme, CT: Greenwich Publishing Group, 2003).

Roundout the Summer with an Antique Power Show

Throughout the summer and early fall, antique power shows large and small occur across the U.S. and Canada. Bryan Coulson of the Northern Ohio SIA Chapter has kindly compiled the following list of events that include an antique mining equipment component. Check out one near you.

Saegertown, PA. Pioneer Steam & Gas Engine Society Show (PSGES) and the Historical Construction Equipment Assn. (HCEA) Chapter Historical Construction & Surface Mining Equipment Show, PSGES Grounds, July 15-17. Info: 814-864-3614; www.little-mountain.com/pioneer.

Burton, OH. Historical Engine Society Antique Power & Steam Exhibition and the Historical Construction & Surface Mining Equipment Show, Century Village, July 29-31. Info: www.hesinc.org.

Wetaskiwin, Alberta. HCEA International Convention & Old Equipment Exposition, Reynolds-Alberta Museum, Aug.

5-7. Info: www.hcea2005.com. Tons of dirt moving, ground breaking, earthshaking antique construction equipment. The Reynolds-Alberta Museum is home to a 1917 Bucyrus Class 24 dragline, claimed to be the world's oldest surviving.

Brownsville, PA. National Pike Steam, Gas, Horse & Construction (NPSGHA) and the Surface Mining Equipment Show, NPSGHA Grounds, Aug. 12-14. Info: 724-356-2307.

Rollag, MN. Western Minnesota Threshers Reunion (WMTR) and the Historical Construction & Surface Mining Equipment Show, WMTR Grounds, Sept. 2-5. Info: www.rollag.com.

Wellston, OH. Wellston Coal Festival, downtown Wellston, Sept. 6-10. In addition to equipment display includes tour of working mine, miner "olympics," parades, etc.

New Athens, OH. Old Construction & Surface Mining Equipment Show, Harrison Coal & Reclamation Historical

(continued on page 19)

Preserving Hermi's Bridge

On the evening of Oct. 25, 1983, an inebriated 16-year-old drove head-on into a car driven by Atlanta architect Cecil Alexander. Alexander was badly injured; his wife, Hermione Weil Alexander, who was a passenger, died. As a tribute to Mrs. Alexander, who was active in civic, philanthropic, and cultural activities in Atlanta and was the first female jury commissioner for Fulton County, the county commission named a bridge—Hermi's Bridge—in her honor. This was especially fitting as the Alexanders had been instrumental in preserving the historic bridge when it had been threatened with demolition nearly a decade prior to the accident.

Constructed in 1903 by the Cotton States Bridge Co. for approximately \$10,000, Hermi's Bridge is a two-span, 280-ft.-long, pin-connected, Pratt, through-truss bridge that carried a single lane of traffic across the Chattahoochee River until it was bypassed in 1972. Located near the private Lovett School, Hermi's Bridge is used by students to walk to athletic fields. In addition, hikers and bicyclists use the bridge as the only pedestrian-friendly crossing of the Chattahoochee in suburban Atlanta.

Except for a new wooden deck and a coat of paint provided by Fulton County, Hermi's Bridge has received little maintenance since it stopped carrying motor vehicles over 30 years ago. Hermi's Bridge is now in need of rehabilitation. The regional planning agency, the Atlanta Regional Commission, has made \$320,000 of federal funds available for inspection and repairs; however, this money requires a matching grant of \$80,000, which county funds will not cover.

Cecil Alexander is heading an effort to raise the matching funds. In a story in the Nov. 4, 2004 *Atlanta Journal-Constitution*, Alexander explained that, "What I hope to do is publicize the situation so we could raise the money." In the same article, Alexander also explained the scope of the proposed work. "The first order of business is an engineering check of the bridge to see if it's safe....They'll need scuba divers to check the foundation. The second will be to replace any fasteners or steel that's inadequate." The third

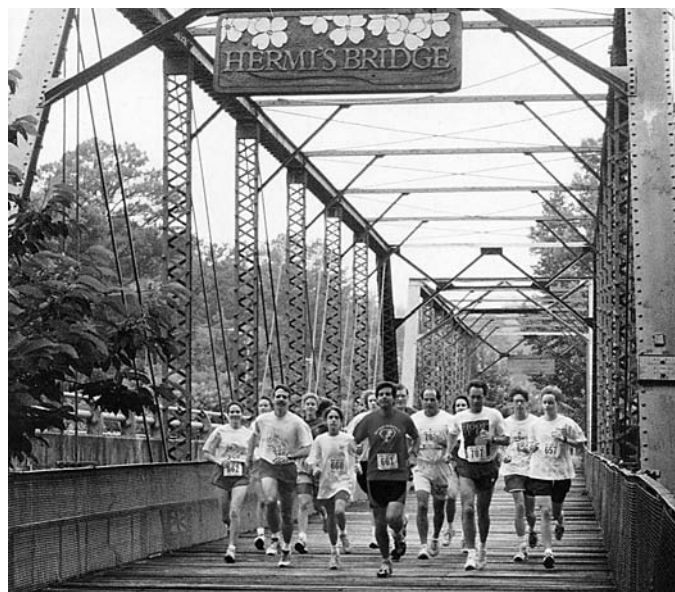

Joe Maher, courtesy Lovett School

Hermi's Bridge over the Chattahoochee River near Atlanta.

thing that needs to be done is to remove the existing paint; this is likely to be an expensive undertaking since the paint is lead-based. And then the bridge will be re-painted. Finally, the wood deck needs to be replaced and the approaches to the bridge need clearing and landscaping as well.

The PATH Foundation, a local non-profit trails group, has endorsed the rehabilitation of Hermi's Bridge. A lifetime Atlanta resident, Alexander was an architect during the building boom in the 1960s and 1970s, so he is well-known. He now wants to use those "connections" to aid in saving Hermi's Bridge. PATH is also reaching out to those with interests in historic bridges from across the country. For information or to make a contribution: PATH Foundation, Box 14327, Atlanta, GA 30324; Attn: Ed McBrayor, Executive Director.

Stephen Goldfarb

HISTORIC IRON—UPCOMING EVENTS

Franconia Furnace 200th Anniversary Celebration. The bicentennial of the beginning of iron smelting in Franconia, NH, will be observed on Sat., July 16, 2005, from 10 am to 3pm. Speakers, blacksmiths, and iron mongers will gather at the Iron Furnace Interpretive Center on Rte. 18 near Rte. 117. Dennis Howe, president of the Northern New England Chapter of the SIA, and Victor Rolando [SIA], leader of the 1996 recording of the furnace, will offer a retrospective on the iron industry as it developed in Franconia from 1805 to 1865. James H. Johnson of the Southern New England Chapter will explain the different types of smelting processes and the differences between cast iron, wrought iron, and steel. Jennifer Stackpole and other blacksmiths will demonstrate their craft. The interpretive center display

includes a scale model of the furnace and casting shed, a forge bellows, tools, and products. The octagonal-plan, stone stack is the principal remaining structure of the iron works. It is the only blast furnace still standing in New Hampshire. In the event of rain, the gathering will be held at the Franconia Heritage Museum, 553 Main St. The event is being organized by the Franconia Area Heritage Council. Info: Jewell Friedman, Curator, Franconia Heritage Museum; (603) 823-5951; dwjaf@ncia.net.

Ironmaking Conference, Oct. 14-16. The North Jersey Historical Society and Friends of Long Pond Ironworks will host the conference at the Lautenberg Visitor Center,

(continued on page 7)

Reinforced-concrete Bowstring Bridge Moved Intact

A reinforced-concrete, bowstring, arch bridge, built in 1924, in Wellington County, Ontario, may have set a new record. In 2003, it was removed from its abutments and trucked off for display. This may be the first time that a bridge of this type has been moved intact for preservation. The decisions to save it, as well as to move it, are intriguing.

It all began when the bridge was deemed too narrow for modern traffic requirements and prohibitively expensive to widen. Replacement was the only viable option. Normal demolition procedures would have collapsed the bridge into the stream and then removed the broken pieces, but because the bridge was relatively short (35 ft.) and light (72 tons), Larry Van Wyck, township manager of public works, decided to lift the span off its abutments and demolish it on shore, thus also avoiding potential ecological impacts on the stream.

In December 2003, the bridge was lifted and trucked to a nearby quarry to be broken up “at leisure.” It was only then that the idea of preservation arose. The County Warden, who was also the mayor of the Township of Guelph Eramosa, decided that the bridge ought to be preserved because of the design’s close historic association to the development of the county’s road system. Not only does the bridge represent early-20th-century modernization of rural roads in Ontario in general, but Wellington County had an inordinate number of this design. Most were built in the 1920s. Why more were built in this county than elsewhere is unknown, but one clue was that a highly proficient contractor, Charles Mattaini, lived in the county and was known to have built many of these bridges. In Oct. 2004, the bridge was trucked to the Wellington County Museum & Archives to be placed on permanent display.

The replacement bridge, while not as visually distinctive as the original arch, is of technical interest in its own right. Saltech Ontario Ltd. has developed a composite wood, steel wire, and fiberglass beam used in conjunction with a structural-steel frame to produce light, pre-engineered bridges (www.saltechontario.com).

Christopher Andreae & Bonnie Callen



Lifting the bridge off the flatbed truck at the Wellington County Museum, Oct. 2004.



The bridge at its permanent location, prior to landscaping, at the Wellington County Museum.

Wellington County Museum & Archives

Sterling Forest State Park, 115 Old Forge Rd., Tuxedo, NY. The event, a revival of the Ironmasters Conference, will celebrate the opening of the new visitor center overlooking Sterling Lake. The center has exhibits on the history of iron mining and manufacturing along with an introductory movie that describes the region and its resources. The conference will begin on Friday at 2 pm with a guided tour of iron sites in Sterling Forest. Paper sessions will be all day on Saturday. On Sunday, a guided tour of the nearby Long

Pond Ironworks Historic District in West Milford, NJ, will begin at 10 am. Iron researchers and enthusiasts are invited to speak at Saturday’s paper session. Presentations should be 25-min. and may be illustrated with slides or other graphic materials. Kindly submit a title and abstract to Edward J. Lenik, Program Chair, 100 Deerfield Rd., Wayne, NJ 07470; edlenik@hotmail.com; or call 973-835-0770 between 9 am and 4 pm. The conference is free and open to the public but advance registration is required.

Conservation of Cotton Gin

The Louisiana State Museum recently conserved a cotton gin for display in the museum's new Baton Rouge facility. The gin is actually composed of the parts of three gins saved from the Union Cotton Oil Mill in 2002 by Ralph Calhoun and Justin French, director and curator respectively of the Beidenharn Museum & Gardens in Monroe. Unfortunately, over-zealous workmen damaged the gins before they could be properly removed under the direction of museum staff. The gin building has since been converted to office space.

Made primarily of wood and metal, the gins are substantial machines weighing approximately 1,000 lbs. and measuring 80-in. high × 60-in. wide × 130-in. long each. The gins bear the original patent date of 1869, but parts in them have been dated from 1869 to 1946, reflecting more than a century of continued use. All of the gins were heavily damaged in one way or another, each one missing a number of parts. International Artifacts, Inc., a conservation lab in Harvey, LA, took parts from two of the gins and added them to the body of a third. Sue Fischer, curator of material culture, was the conservation monitor, and Lynn



One of the cotton gins still in place in the Union Cotton Oil Mill, 2002.

Harrington of International Artifacts supervised the work.

Photographs and sketches were taken during the entire conservation process. All cleaning was done by hand. As much as three inches of cotton oil coated the gins. This coating fortunately served as a protective barrier for both wood and metal. Denatured alcohol was used to remove the cotton oil from the wood, and the metal parts were dipped in kerosene and washed in water. Denatured alcohol was then applied to the metal surfaces to remove any remaining cotton oil and kerosene. The gins were originally painted green and much of the paint survived and was preserved. The remnants of the gin's lint drum brushes were preserved and remain in place.

The Eleazer Carver Gin Co. of Bridgewater, MA, manufactured the gins. Carver began production in 1816 and ranks as one of the nation's earliest

gin makers. Considered a superior mechanism, the Carver gin competed with southern companies for the New Orleans market, and it was one of the few northern companies that flourished in Louisiana. Cotton ginned on the Carver machine often brought more money per pound of cotton.

The conserved gin will be prominently displayed in an exhibit on the "natural abundance" of Louisiana in the new Baton Rouge state museum, scheduled to open in October 2005.

Greg Lambousy

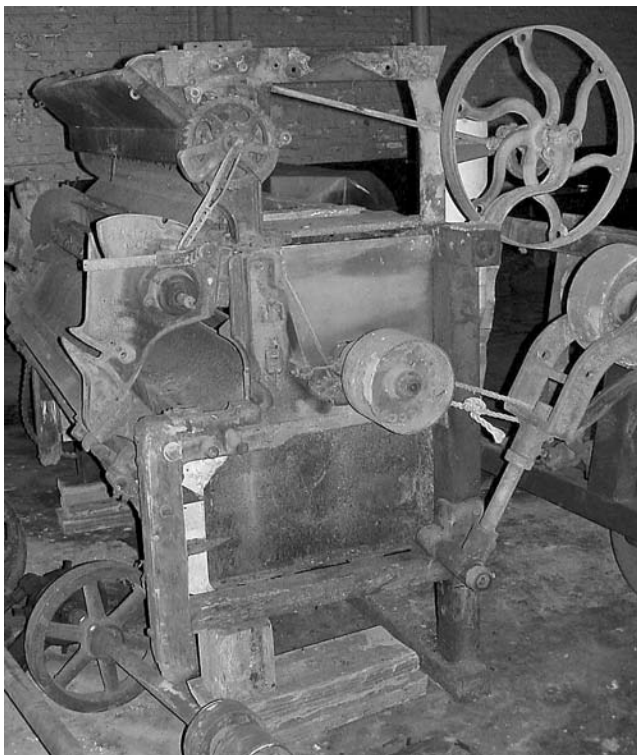

The oil-coated gins were inspected and found to be in poor condition due to missing and damaged pieces.

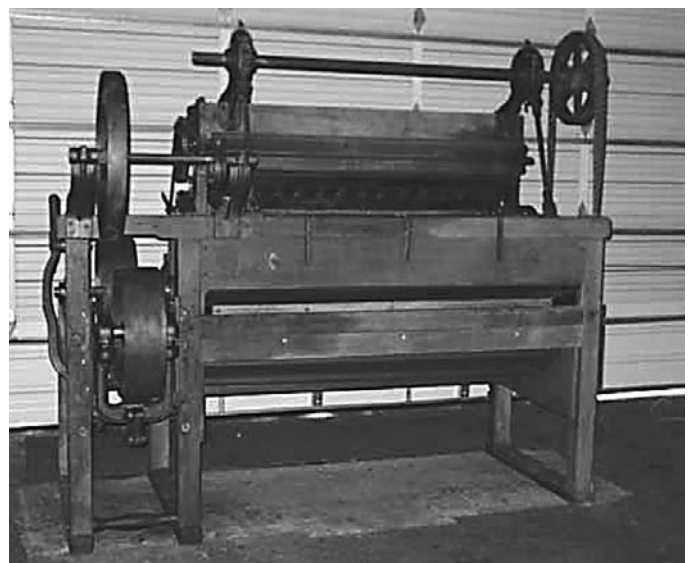

The conserved Carver cotton gin ready to be transferred from the warehouse for display at the Louisiana State Museum.

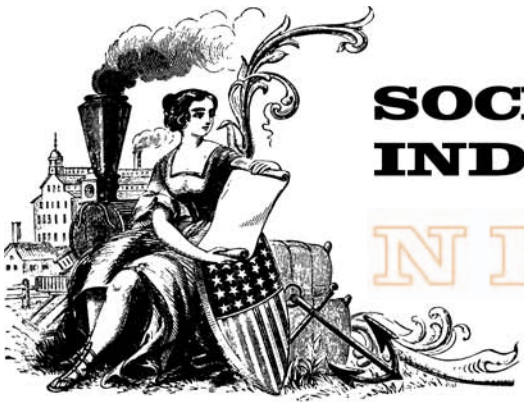

SOCIETY FOR INDUSTRIAL ARCHEOLOGY

NEWSLETTER

PUBLICATIONS OF INTEREST

Vol. 34, No. 2

Spring 2005

COMPILED BY

Mary Habstritt, New York, NY; and Patrick Harshbarger, SIAN editor.

GENERAL INTEREST

- ◆ **Future Anterior** (www.arch.columbia.edu/futureanterior) is a new academic journal devoted to the study and advancement of historic preservation published by Columbia University's graduate program. Vol. 1, No. 1 includes Shawna Richardson, *Industrial Evolution: Preservation Through Judicious Demolition of 20th-Century Industrial Buildings*, pp. 47-56, with a discussion of the Union Iron Works and Bethlehem Steel shipyard in San Francisco.
- ◆ Frank Tobias Higbie. **Indispensable Outcasts: Hobo Workers and Community in the American Midwest, 1880-1930**. Univ. of Illinois Pr., 2003. 262 pp. \$44.95; \$18.95 paper. Transient workers provided indispensable muscle but never belonged to the communities in which they worked. Midwestern hoboes moved among iron mines, logging camps, and harvest fields of Minnesota, Wisconsin, and the Dakotas.
- ◆ Lance Metz, ed. [SIA]. **Canal History and Technology Proceedings 24**. Canal History and Technology Press (National Canal Museum, 30 Centre Sq., Easton, PA 18042; 610-559-6613). 244 pp. \$24.50 ppd. Papers presented at the annual conference includes Paul G. Marr, *The Wiconisco Canal*; Robert J. Kapsch [SIA], *The Santee Canal: America's First Summit-Level Canal*; Thomas J. Blalock [SIA], *The Bethlehem Steel Works During the Early 20th C. and the Development of Its Electrical Power System*; John B. Lovis, *The Blast Furnaces of Sparrows Point (1857-1957): The History of Ten Furnaces and a Company Town*; James J. Bohning, *Angel of the Anthracite: The Philanthropic Legacy of Sophia Georgina Coxie*; Charles D. Wrege and Guidon A. Sorbo, Jr., *A Bridge Builder Changes a Railroad: The Story of Daniel Craig McCallum*; and Emory L. Kemp [SIA], *Benjamin Franklin Thomas and the Introduction of the French Needle Dam into the United States*.
- ◆ Julia Solis. **New York Underground: The Anatomy of a City**. Routledge, 2004. 251 pp., photos. \$35. An urban explorer and artist documents her journeys under NY City, through the bowels of Grand Central Terminal, abandoned subway stations, steam tunnels beneath Pratt Institute, and more.
- ◆ Jenny Uglow. **The Lunar Men: Five Friends Whose Curiosity Changed the World**. Farrar, Straus and Giroux, 2002. 608 pp. \$30; \$15 paper. Portrait of England's 18th-c. "Lunar Society of Birmingham," a group of five friends who played an instrumental role in England's industrial revolution by planning to build canals and harness electricity, and named plants, gases, and minerals. The five were Josiah Wedgwood, ceramics industrialist; Matthew Boulton, toymaker, and his partner James Watt, Scottish improver of the steam engine; Erasmus Darwin, physician and inventor; and Joseph Priestley, the chemist who isolated oxygen.

BRIDGES

- ◆ Eric DeLony [SIA] and Terry Klein. **A Heritage at Risk: Report on Workshop on the Preservation and Management of Historic Bridges, Washington, DC, Dec. 3-4, 2003**. An unofficial summary of a meeting of engineers, preservationists, and government officials to discuss and make recommendations on historic bridge preservation problems and issues. Available on-line: www.srifoundation.org.
- ◆ Joe Flanagan. **Spanning America: The Historic American Engineering Record Documents a Legacy of Covered Bridges**. *Common Ground* (Winter 2004), pp. 26-37. Illustrated article describes the federal project to document through photographs, drawings, and narratives the nation's covered bridge heritage. Features Jet Lowe, Eric DeLony, and Lola Bennett [all SIA].
- ◆ Tim Mancl and Marty Cobbs [SIA]. **Rehabilitation of the Ferry Street Bridge, New Haven, Connecticut**. *SIA New England Chapters Newsletter* v. 25, no. 1 (2004), pp. 9-11. Double-leaf bascule bridge, built in 1940, over the Quinnipiac River.
- ◆ Brian Merlis and Lee Rosenzweig. **Spanning the Narrows: Celebrating the 40th Anniversary of the Verrazano-Narrows Bridge, 1964-2004**. Israelowitz Publishing (Box 228, Brooklyn NY 11229; 718-951-7072; www.israelowitzpublishing.com), 2004. 80 pp., photos. \$24.95. Construction of the bridge.
- ◆ John Thompson. **Jackson Bridge's Future in Jeopardy**. *Idaho Farm Bureau Quarterly* (Fall 2004), pp. 34-35. Efforts to preserve steel girder bridge (built in 1916, rebuilt in early 1950s) over the Snake River in Cassia Co. Emphasis is not so much on the bridge's technology as its relationship to the rural community, including memories of square dancing on the bridge.
- ◆ Malcolm Tucker. **Timely Rescue of Brunel's Canal Bridge**. *IA News* 129 (Summer 2004), pp. 2-3. Describes little-known I. K. Brunel cast-iron girder bridge of 1838 over the Grand Union Canal at Paddington in west London. Bridge had been concealed in brickwork since about 1909, but was rediscovered and dismantled for preservation during a road-widening project.

BUILDING & STRUCTURES

- ◆ **Context** is the journal of the Institute of Historic Building Conservation (UK). Articles draw attention to current issues in the preservation, repair, and maintenance of historic buildings. The journal is available with membership in the institute. Some articles are made available to a wider audience via the Internet. Info: www.ihbc.org.uk.
- ◆ Albert H. Good. **Patterns from the Golden Age of Rustic Design: Park and Recreation Structures of the 1930s**.

AltaMira Press (1-800-462-6420), 2003. 632 pp., illus. \$29.95. Plans for cabins, lodges, hotels, fireplaces, boat houses, and other rustic structures commonly found in state and national parks.

- ◆ T. A. Heppenheimer. **Cold Comfort.** *I&T* (Spring 2005), pp. 26-37. It took half a century for air conditioning to become accepted and decades more for it to become universal. The history of the modern air-conditioned building and the technology that keeps it cool prominently features the Carrier Engineering Co.
- ◆ Lee Hockstader. **Once the 'Eighth Wonder,' Now a Relic.** *Washington Post* (June 8, 2003), p. A03. A marvel of 1960s engineering, Houston's Astrodome was the world's first domed, climate-controlled stadium. The challenges of preserving and finding a re-use for it, now that it has lost its professional sports teams to newer stadiums.
- ◆ Joseph M. Siry. **The Chicago Auditorium Building.** Univ. of Chicago Press, 2002. 580 pp., illus. \$28 paper. Adler and Sullivan's 1887-89 Auditorium Building is considered one of the masterpieces of its kind, a four-thousand-seat theater with masonry bearing wall and interior iron frame of unprecedented scale when built. This history is dense in detail, covering the building's funding, design, and construction, and is as much social history as architectural.
- ◆ Charles Waldheim and Katerina Ruedi Ray, eds. **Chicago Architecture: Histories, Revisions, Alternatives.** Univ. of Chicago Press, 2005. 488 pp., illus. \$28. Contributors to this volume assert in various ways that the mythic status of Chicago architecture has distorted our understanding of the historical circumstances in which it was realized.
- ◆ Sara Wermiel [SIA]. **Heavy Timber Framing in Late-Nineteenth Century Commercial and Industrial Buildings.** *APT Bulletin* v. 35, no. 1, 2004, pp. 55-60. Compares details of slow-burning or mill construction with warehouse construction, the latter used to build city lofts. Also, **No Exit: The Rise and Demise of the Outside Fire Escape.** *T&C* 44 (Apr. 2003), pp. 258-284. Story of how public regulation created the outside fire escape as a means to save people in building fires; how changes in regulation shaped the form of fire escapes, until they finally were prohibited as a means of egress on large buildings.

POWER GENERATION

- ◆ Barry Lee David. **The Antique American Steam Gauge.** Astragal Press (www.astragalpress.com), 2003. 304 pp., photos. \$35. A collector's guide. Compiles a tremendous amount of information to help identify a gauge: when it was made, what job it was designed to do, how it did this job, who made it, and for what company it was made.
- ◆ Tim Palucka. **The Wizard of Octane.** *I&T* (Winter 2005), pp. 36-45. Eugene Houdry of Sun Oil, inventor of the catalytic-cracking unit that produced high-octane fuel from crude oil and replaced stills. First full-scale Houdry catalytic-cracking unit was at Sun's Marcus Hook, PA refinery (drive-by site—2004 Fall Tour, Wilmington).
- ◆ Jim Quinn. **Edison's Light Turns 125: An Amazing Breakthrough—and Its Unintended Consequences.** *I&T* (Winter 2005), pp. 8-9. Celebrates Edison's invention of the incandescent light in 1879, but also looks at the consequences of the inefficient light-bulb design that has changed very little in 125 yrs. More than 90 percent of the energy consumed by an incandescent bulb produces heat instead of light.

- ◆ Joshua Rose. **Modern Steam Engines: An Elementary Treatise upon the Steam Engine.** Astragal Press (www.astragalpress.com), 2003. 322 pp., illus. \$29.95. Reprint of 1887 ed. Author was a mechanical engineer whose classic book gave full details of the construction of steam engines, illustrating their operation with clear and understandable drawings. Engravings show the operations of various valves, valve motions, link motions, etc.
- ◆ Frederic D. Schwarz. **The Littlest Refinery.** *I&T* (Winter 2005), p. 10. Efforts to preserve the Lusk, WY, oil refinery (*SIAN*, Winter 1999). The outer cases of its stills were made in the 1850s by the Erie City (PA) Iron Works.
- ◆ Paul Wellstone and Barry M. Caspar. **Powerline: The First Battle of America's Energy War.** Univ. of Minnesota Pr., 2003 reprint. 314 pp. \$17.95. Chronicles west-central Minnesota's populist protest against high-voltage powerlines that crossed farm fields from North Dakota to the Twin Cities' suburbs.

TEXTILES

- ◆ Chuck Williams. **Modern Mill.** *Columbus (GA) Ledger-Enquirer* (Mar. 27, 2005; www.ledger-enquirer.com). Describes the multi-purpose residential and commercial adaptive re-use of the Eagle & Phenix cotton mill in downtown Columbus. Buildings at the 16-acre complex date from 1868 to the early 20th c.
- ◆ Stephen Yafa. **The Man Who Made Cotton King.** *I&T* (Winter 2005), pp. 50-57. Recounts Eli Whitney's development of the cotton gin and its role in the industrial revolution.

MINES & MINING

- ◆ Ed Dougert. **The Black Land: Remnants of the Once & Great Anthracite Coal Industry, A Photographic Essay.** Schuylkill Living Magazine (Erica Ramus, Editor/Publisher, 115 S. Centre St., Pottsville, PA 17901; 570-622-8625; eramus@comcast.net), 2003. 98 pp. \$19.95. Photos of structures and landscapes left behind by coal mining operations, including some, like the Locust Summit Breaker, now gone.
- ◆ Peter Goin and Elizabeth Raymond. **Changing Mines in America.** Univ. of Chicago Pr., 2004. 240 pp. \$27.50. Explores the birth and death of mining towns and their transformation to other uses, from tourist attractions to sites for hiking, through comparative historical and modern photographs. First chapter focuses on Minnesota's Mesabi iron range, but one of the most arresting depictions is of the Sunshine Radon Health Mine in Montana where visitors descend an 85-ft. shaft to absorb radon in this mine turned spa.
- ◆ John R. Park. **Missouri Mining Heritage Guide.** Stonerose Publishing (7741 SW 59th Ct., S. Miami, FL 33143-5112; stonerosepub.home.att.net). 279 pp., photos, maps. \$22.95 ppd. A history of the mineral resource industries of Missouri disguised as a travel guide. This is the third in the *Mining Heritage Guide* series; others published to date include Maryland and New Mexico. The Missouri volume has 421 entries of mining history-related points-of-interest (mostly visitable sites), including museums, mines (historic and operating), mining towns, monuments, and mining-related sites of all types including refining and manufacturing operations associated with mineral resources.

IRON & STEEL

- ◆ **General Society of Mechanics and Tradesmen Library Steel Bibliography.** The NYC library has produced a bibliography that lists items in its collection on the subject of steel. If you would like a copy, please send a request by e-mail to library@generalsociety.org. Please specify whether you would like the bibliography by e-mail or in hardcopy.
- ◆ Paul Glader. **Monuments to Labor: Defunct Iron and Steel Works Become Tourist Attractions.** *Wall Street Journal* (Aug. 10, 2004), p. B1. Tourist potential of several sites including Sloss Furnaces NHL and the National Museum of Industrial History in Bethlehem, PA.
- ◆ Mark Reutter. **Making Steel—Sparrows Point and the Rise and Ruin of American Industrial Might.** Univ. of Illinois Press, 2004. 533 pp. This is an update of the author's 1988 edition and takes the story of the Baltimore steel plant [tour site—1995 Annual Conference] to the official end of Bethlehem Steel with its sale to ISG in 2004. The updated edition, as with the original, is only moderately illustrated, but there are some new photos. With the pending sale of ISG to the Mittal interests, events have already overtaken the publication but the author keeps updating www.makingsteel.com. (UofI press distributes the softbound version of the book, while the author has underwritten a hardbound edition, sold through the Web site.)

RAILROADS

- ◆ A. J. Bianculli. **The Westinghouse “Triple Valve” and Its Operation.** *R&LHS Newsletter*, v. 24, no. 4 (Autumn 2004), pp. 17-20. Explanation with diagrams of George Westinghouse's automatic air brake developed in the 1870s.
- ◆ George A. Forero, Jr. **The Copper Range Railroad and the Copper Country.** *Mid-Continent Railway Gazette*, v. 37, no. 4 (Dec. 2004), pp. 1-42. Map, photos. Comprehensive history of the railroad that served Michigan's Keweenaw Peninsula copper mining region from 1899 to 1972.
- ◆ Oscar Israelowitz and Brian Merlis. **Subways of New York in Vintage Photographs.** Israelowitz Publishing (Box 228, Brooklyn NY 11229; 718-951-7072; www.israelowitzpublishing.com), 2004. 250 pp., photos, maps. \$34.95. Commemorating the 100th anniversary of the subway system, contains many “never before

CONTRIBUTORS TO THIS ISSUE

Richard K. Anderson, Jr., Sumter, SC; Christopher Andraea, Delaware, ON; Bob Bernacki, Bloomington, IN; George Bulow, New York, NY; Bonnie Callen, Wellington, ON; Robert Chidester, Jackson, MI; Arlene Collins, Houghton, MI; Bryan Coulson, Holloway, OH; Marilyn Day, Westford, MA; Eric DeLony, Santa Fe, NM; Don Durfee, Houghton, MI; Betsy Fahlman, Tempe, AZ; Bob Frame, Minneapolis, MN; Jewell Friedman, Franconia, NH; Jane Mork Gibson, Norristown, PA; Stephen Goldfarb, Atlanta, GA; Paul Graham, Columbus, OH; Mary Habstritt, New York, NY; Neill Herring, Jesup, GA; Tom Hull, Coos Bay, OR; Sam James, Wynnewood, PA; Greg Lambousy, Baton Rouge, LA; Schuyler Larrabee, Newtown Centre, MA; Ken Lavelle, N. Royalton, OH; Carol R. Lockman, Wilmington, DE; Bode Morin, Detroit, MI; John Park, South Miami, FL; Dave Poirier, Hartford, CT; Lynn Rakos, Brooklyn, NY; Bob Rawls, Burnt Hills, NY; Judith Reiter, Milford, MI; Stuart Smith, Camborne, Cornwall, UK; Nancy Solomon, Denver, CO; John Teichmoeller, Ellicott City, MD; Robert Vogel, Washington, DC; Sara Wermiel, Jamaica Plain, MA; Suzanne Wray, New York, NY; Helena Wright, Washington, DC.

With Thanks.

seen” photos including construction scenes. Many views of the Second, Third, Sixth, and Ninth Avenue Manhattan els as well as elevated lines in the outer boroughs.

- ◆ Stephan M. Koenig. **South Buffalo Railway.** South Platte Press (www.southplattepress.com), 2004. 120 pp., softbound. Copiously illustrated story of Bethlehem Steel's captive railroad that served its Lackawanna (Buffalo) works from 1899 to its sale to Genessee & Wyoming in 2001. Includes locomotives, rolling stock, facilities, track diagrams, and aerial photos, mostly focused on the railroad but with some steel mill scenery.
- ◆ Schuyler Larrabee [SIA]. **Erie's B-Class 0-6-0's.** *The Diamond*, v. 17, nos. 1 and 2. History of this class of switching locomotives, including drawings. Ample illustrations. Avail: Erie-Lackawanna Historical Society, 10-10 Ellis Ave., Fair Lawn, NJ 07410. \$9.95 per issue.
- ◆ Tommy Meehan. **Philadelphia's Broad Street Lady.** *R&LHS Newsletter*, v. 24, no. 4 (Autumn 2004), pp. 4-8. History of the various iterations of Pennsylvania RR's Broad Street Station from the 1880s to the 1950s.
- ◆ Claire Strom. **Profiting from the Plains: The Great Northern Railway and Corporate Development of the American West.** Univ. of Washington Pr., 2003. 228 pp. \$35. After reorganizing the Great Northern in 1889, James J. Hill began a calculated push to reach Puget Sound without additional federal land subsidies. To do so, he adopted a number of strategies to promote agricultural development in and attract settlers to the northern tier states. Rev.: *Minnesota History*, 59:3 (Fall 2004), pp. 133-4.

WATER TRANSPORT

- ◆ Michael Bernstein [SIA]. **On the Job for Victory: News Publications of the Emergency Fleet Corporation, 1918-1919.** *Nautical Research Journal*, v. 50, no. 1 (Spring 2005), pp. 1-10. Review and analysis of the types of information and source materials to be found in *Emergency Fleet News*, *Emergency Fleet Bulletin*, and *Shipyard Bulletin*, illustrated periodicals of the merchant shipbuilding program during the latter part of WWI. Topics covered include steel ship construction; requisitioned ships; innovations in steel ship construction, repair, and improvement; wood ship construction; concrete ship construction; tallies of ship construction; and cartoons.
- ◆ Kevin Bone, ed. **The New York Waterfront – Evolution and Building Culture of the Port and Harbor.** Monocelli Press (902 Broadway, New York, NY 10010), updated ed., 2004. \$40. Update of the original 1997 edition includes essays and photographs about the port and its history. George Bulow [SIA] writes, “As a New Yorker who grew up in the 1950s and 60s and remembers what the twilight of the ocean liner, and even the occasional discharge of an ocean freighter, along the Manhattan shoreline was like, the welter of material in this book and the superb collection of photographs, drawings, and engineering renderings have afforded some excellent insights into how our port developed and grew with the city.”
- ◆ Nancy and Robert Goodman. **Paddlewheels on the Upper Mississippi, 1823-1854: How Steamboats Promoted Commerce and Settlement in the West.** Washington County Historical Society (Box 167, Stillwater, MN 55082; 651-439-5956; www.wchsmn.org), 2003. 155 pp., illus. \$20 ppd. With the arrival of the first steamboat at Ft. Snelling, a stampede of traders and settlers arrived in the Minnesota region. Steamboat life for both workers and travelers is described in detail. Rev.: *Minnesota History*, 59:3 (Fall 2004), pp. 132.

- ◆ Tom Huntington. **The Hunley**. *I&T* (Spring 2005), pp. 38-46. Concise history and wrap-up of the recent activities to salvage and conserve the CSS *H. L. Hunley*, the ill-fated Civil War submarine that sank off the coast of Georgia in 1864.
- ◆ Robert Kapsch [SIA]. **Canals: Norton/Library of Congress Visual Sourcebook in Architecture, Design, and Construction**. Norton (1-800-233-4830; www.npbcatalog.com), 2004. Richly illustrated history of American canals describes the development of these waterways in their heyday and shows the varied structures—locks, lockhouses, aqueducts, bridges, dams, and tunnels. It provides a capsule tour of 35 canals and a visual journey along two of the most famous canals: the C&O and the Morris. 800 illustrations from the Library of Congress are reprinted. Comes with a CD-ROM containing all of the illustrations in TIFF format for Mac and PC. List price is \$75. Available to SIA members at a 20% discount (\$60) by mentioning sourcecode [OCS 924](#) when ordered directly from the publisher.
- ◆ Virginia Thorndike. **On Tugboats: Stories of Work and Life Aboard**. Down East Books, 2004. 384 pp. Crews and captains tell of working on tugs on the coasts and waterways of America.

WATER CONTROL & DEVELOPMENT

- ◆ John O. Anfinson with Thomas Madigan, Drew M. Forsberg, and Patrick Nunnally. **River of History: A Historic Resources Study of the Mississippi National River and Recreation Area**. St. Paul District, Corps of Engineers, 2003. The 72-mile corridor of the MNRRA, from the Crow River to the Vermillion, includes Lock and Dam Nos. 1 and 2 and the Minneapolis Upper Harbor Project, as well as riparian industries from lumbering to flour milling to hydroelectricity.
- ◆ Barry Barton. **Water Towers of Britain**. Newcomen Society (Book Sales Dept., Box 421, Elmswell, Bury St Edmunds IP30 9XF, U.K.; ph. +44 01359 242566), 2003. 240 pp., photos, maps. £28.50. The development of public water supplies in the early Victorian era, often under the patronage of municipalities, country estates, and water boards, is explored through this study and gazetteer of water towers. Even though the towers had the same basic function of storing water, most were individual designs reflecting a fascinating variety of sizes, shapes, forms, and styles that defied standardization.
- ◆ George Black. **The Trout Pool Paradox: The American Lives of Three Rivers**. Houghton Mifflin, 2004. 327 pp., illus. \$24. The Housatonic's two main tributaries, the Shepaug and the Naugatuck, were developed quite differently even though attempts were made to industrialize both. Due to twists of fate and timing the Shepaug remained a mostly rural stream, while from Naugatuck's banks sprang Waterbury, the brass capital of the world, and such an explosion of industry and settlement that fresh water was diverted from the Shepaug to alleviate the resulting pollution. Subsequent efforts to undo the damage, including dam removal, are detailed. Rev.: *NY Times Book Review* (May 9, 2004), p. 13.
- ◆ Cornelis Disco and Jan van den Ende. **"Strong, Invincible Arguments"? Tidal Models as Management Instruments in Twentieth-Century Dutch Coastal Engineering**. *T&C*, v. 44, no. 3 (July 2003), pp. 443-69. Tidal models used by hydraulic engineers to predict the propagation of ocean tides into bays and rivers in the 1930s, not just technical tools but management tools to mobilize political support for their massive hydraulic projects.

AUTOMOBILES & HIGHWAYS

- ◆ **American Road** is a new magazine that celebrates the history of the American highway with articles on traveling and touring old routes like the Lincoln Highway and Route 66. Published quarterly. \$15.95/yr. www.mockturtlepress.com; 1-877-285-5434.
- ◆ George P. Blumberg. **Hudsons Survive: The Dealer Does, Too**. *NY Times* (Apr. 11, 2003), p. D10. Miller Motors Hudson in Ypsilanti, MI, has been displaying and selling Hudsons and Hudson parts since 1929, even though the last new Hudson was made in 1957.
- ◆ Lolita Hernandez. **Autopsy of an Engine and Other Stories from the Cadillac Plant**. Minneapolis: Coffee House Press (www.coffeehousepress.org; 612-338-0125), 2004. 175 pp. \$14. Twelve stories bring to life Detroit's Clark St. Cadillac factory until the final Fleetwood rolled off the line.
- ◆ **News Closeup—Looking Back Down the Road: National Park Service Studies One of the First Interstates**. *Common Ground* (Winter 2004), pp. 4-5. Project to document and preserve the Lincoln Highway, which stretches from New York to San Francisco.
- ◆ Bill Poovey. **Antique Tires for Antique Cars**. *Knoxville [KY] News* (Oct. 18, 2003). Coker Tire Co. with headquarters in Chattanooga, TN, owns more than 800 vintage tire molds, acquired from original manufacturers, like U.S. Royal and Michelin. Production facility for vintage tires is located in Fresno, CA.

MISC. INDUSTRIES

- ◆ Brian Dolan. **Wedgwood: The First Tycoon**. Viking, 2004. 396 pp., illus. \$24.95. Biography of Josiah Wedgwood, who headed one of the first truly global firms. Based on technological experimentation to improve the quality of English ceramics and shrewd marketing, the manufacturing operation has been in continuous production since 1774. Rev.: *NY Times Book Review* (Nov. 14, 2004), p. 53.
- ◆ Mariana Gosnell. **Everybody Take a Seat**. *Smithsonian* (July 2004), pp. 74-78. Evolution of the resin outdoor chair with description of its manufacture at Grosfillex plant in Robeson, PA.
- ◆ William Hammack. **The Greatest Discovery Since Fire**. *I&T* (Spring 2005), pp. 48-56. The history and development of the microwave oven from the 1940s to 1960s. Raytheon and Amana were the major players.

ABBREVIATIONS:

APT	= Association for Preservation Technology
I&T	= American Heritage of Invention & Technology
IA News	= Industrial Archaeology News, Bulletin of the Assn. for Industrial Archaeology (UK)
R&LHS	= Railway & Locomotive Historical Society
T&C	= Technology & Culture, Quarterly of the Society for the History of Technology

Publications of Interest is compiled from books and articles brought to our attention by you, the reader. SIA members are encouraged to send citations of new and recent books and articles, especially those in their own areas of interest and those obscure titles that may not be known to other SIA members. *Publications of Interest*, c/o SIA Newsletter, 305 Rodman Road, Wilmington, DE 19809; phsianews@aol.com.

SIA Industrial Heritage Preservation Grants

The SIA Grants Committee is pleased to announce the award of three more Industrial Heritage Preservation Grants. At the October board meeting, the committee recommended and the SIA board approved a \$1,067.50 grant to the Mid-Continent Railway Historical Society, Inc. At its February meeting, the board approved grants of \$2,500 to the Heritage Conservation Network/Francis Mill Preservation Society and \$3,000 to the Western Reserve Historical Society.

Mid-Continent Railway Historical Society requested funding to conduct photo documentation of the 1905 Great Northern Business Car A-22, built in the railroad's St. Paul shops for Louis Hill. The documentation will become part of the society's archival record and will be used in the formulation of restoration and interpretation plans for the car.

Francis Mill Preservation Society (FMPS) is working with the Heritage Conservation Network (a non-profit group that runs hands-on workshops) to restore a c.1887 water-powered gristmill in Waynesville, NC. The mill was in danger of collapse in 2003 when emergency stabilization of the structure took place. Through a series of workshops, the society will not only restore the mill but also teach volunteers about historic construction techniques. FMPS plans to restore the mill and its original equipment to working order and provide access to students and the general public for educational purposes.

Western Reserve Historical Society (Cleveland, OH) will use the grant to help match a challenge grant from the National Endowment for the Humanities to catalog and preserve the records of the LTV Steel Corporation and its predecessors. The records span a 150-year history that ended in 2002 with the company's closing. Once the material is processed, it will be distributed to repositories appropriate for the collection's "geographic scope," which included steel mills, mines, and shipping facilities throughout much of the Midwest and portions of the Atlantic coast. The collection consists of 3,800 cubic ft. of documents, audio and videotapes, and photographs. Upon completion, anticipated to be in 2006, a catalog of the collection will be posted on the Internet.

Recipients of the SIA Industrial Heritage Preservation Grants are required to provide SIA with auditable accounts of the money expended, two copies of products generated from the funded project, and a written report for the SIAN or journal. The SIA grants support the research, documentation, and preservation of industrial sites and practices. Grant guidelines are available at www.sia-web.org. Interested parties are encouraged to contact a member of the SIA Grants Committee for further information: Bode Morin (bodemorin@msn.com, 313 297-8373); Lynn Rakos (brakos@hotmail.com, 917-790-8629); and Nancy Hatchel (440-951-6069).

Mark Your Calendars!

DETROIT—Fall Tour, Sept. 29-Oct. 2

The Fall Tour will take us to the Motor City. The opening reception will be at the Ford Motor Co.'s Piquette Ave. plant where the Model T was first developed and manufactured. Several automotive parts suppliers are on the tentative process-tour itinerary, including New Center Stamping that is making replacement grills for '62 pickups, among other items, on original equipment. Also on the list of possible sites are the auto-design studios of the College of Creative Studies, Fairlane Manor, Ford Field, the Rivera Murals, and the Bettermaid Potato Chip factory. We will have a private visit to the new Ford Rouge Factory Tour operated by the Henry Ford Museum.

A highlight of the tour will be a three-hour boat trip from downtown Detroit, under the Ambassador Bridge, up the Rouge River to the turning basin at Ford's Rouge Plant. En route, we will pass under several drawbridges, sail by Historic Fort Wayne, and see no less than two steel plants, six blast furnaces, one salt mine, one wastewater treatment plant, one gypsum plant, remnants of the rail ferry, two cement plants, one power plant, the Dockyard, and the first international power-sharing cable crossing. The river should be active, so it is likely we will see several freighters.

Additional Info: Check the SIA Web site (www.sia-web.org) for conference and tour updates, or contact the SIA's Events Coordinator, Mary Habstritt, events@siahq.org; 212-769-4946. Registration materials will be sent to all members approximately two months before the event.

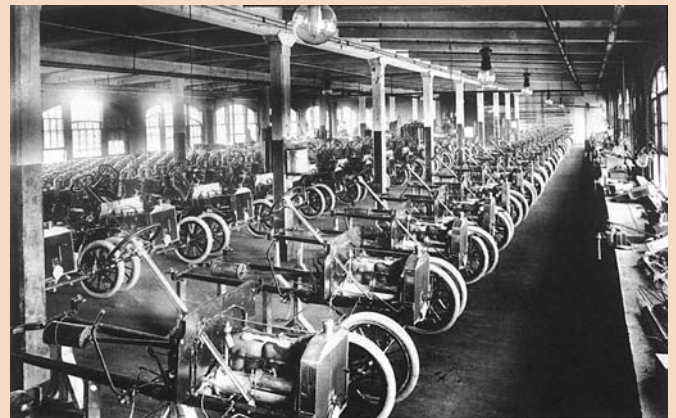

Henry Ford Museum.

Interior of Ford's Piquette Ave. Plant (c. 1906-10) will be the site of the opening reception for the SIA's 2005 Fall Tour, Detroit.

Henry Burden's Horseshoe Machines

Robert Rawls [SIA] is a retired machinist with more than 40 years experience.

He now volunteers his time in the machine shop of the Watervliet (NY) Arsenal Museum.

His article describes the experience of building model horseshoe machines based on the patents of Henry Burden.

A few years ago I became interested in Henry Burden and the Burden Iron Works of Troy, NY, following a lecture on the history of the horseshoe. Burden, as I discovered, was a 19th-century mechanical genius who had taken the age-old handcraft of forging horseshoes and mechanized it. Although the lecture provided ample details of Burden's life—his training in mechanics in his native Scotland, emigration to the U.S. in 1819, and personal connections with the influential Van Rennselaer family—it did not answer my questions about the actual manufacture of the horseshoes. Unfortunately, the machines had been lost to WWII scrap drives.

Approximately six months later, while in a bookstore, I stumbled on an article that told of the importance of the Burden Iron Works during the Civil War. Burden reportedly made a horseshoe every second, filling ninety percent of the Union Army's considerable needs. The Confederacy even had sent a spy in an attempt to steal plans for the machines. A warrant was issued for the spy's arrest, but he was not captured. Burden produced wrought-iron horseshoes in six sizes and muleshoes in four sizes. Confident in the quality of its product, Burden advertised, "Let anyone shoe a horse on one side with these shoes and on the other side with the best hand-made shoes, of the same wearing surface and thickness, and he can judge for himself which he would prefer."

Further research led me to Burden's patents. The first dated to 1835, and was followed by a series of improvements dated 1843, 1857, and 1862. The earliest patent revealed that the horseshoes were turned on the pitch line of the gear and the turning gear turns twice as fast as the other. A pitch line is the imaginary line, or friction surface, as gears roll together. Burden's patent issued the challenge: "Anyone familiar with mechanics should be able to build my machine and make horseshoes." I finally understood how the horseshoe was turned into the U-shape. I could visualize the basic construction, but I decided that modeling would be the best way to understand the operating details.

The basic operation as described in Burden's 1835 patent consisted of three machines. The operator started the first

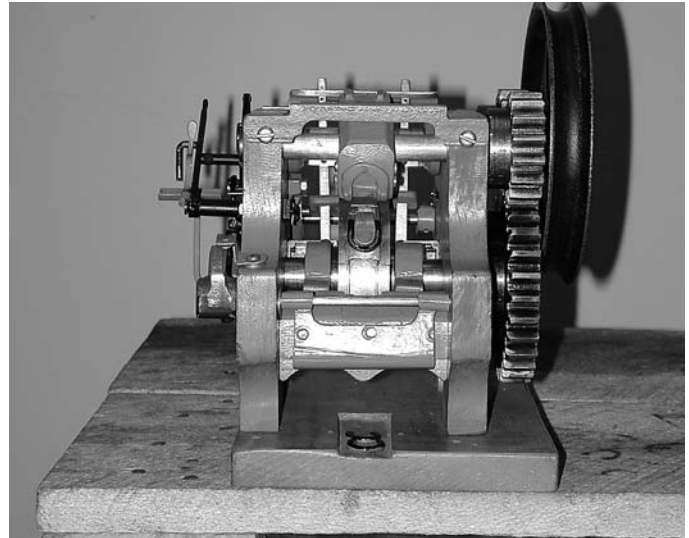

The model of Burden's 1857 machine.

machine, engaging the belt and pulley system, then placed the heated wrought-iron bar stock in the holder while the machine was in motion. During the moving frame return cycle, the operator manually pushed the rod into the moving jaw, or vise, then a cam on the frame closed the jaw, first cutting the bar to length. On the forward cycle, the swages, or forming dies, contoured the stock, thinner on the inner edge. The swages were cast-iron sections held in place by adjusting screws and bolts. Each section could be adjusted for a specific size shoe or for front and back shoes. After swaging, another cam opened the jaw and the swaged rod would fall through the key slot in the moving frame. The swaged pieces were returned to the furnace for reheating and then swaged by the second machine that formed the grooves and punched the nail holes using a similar process.

After reheating the shoe, a third machine turned it into a U-shape. A 4-ft-diameter flywheel provided motion to the rack and pinion gear with the pinion shaft communicating rotary motion to the mating gears with a gear ratio of 2:1. The larger gear had a cam and forming swage bolted to its

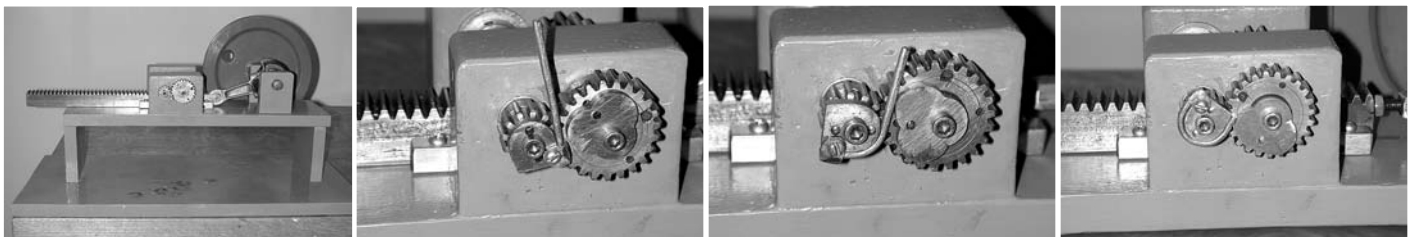

The model of Burden's patented horseshoe-bending machine shows the bending process.

Robert Pffel.

face to act as a lever while the smaller gear had a U-shaped swage bolted to its face to form the horseshoe. A cam opened the nipper to hold the manually inserted, heated bar stock. As the gears and swages revolved together the horseshoe was formed. Completing the cycle, a cam opened the nipper to release the horseshoe. Once in motion the machine ran continuously. When the machine reached its furthest travel, the dead center provided time for the attendant to load another piece of iron. Though not specified in Burden's 1835 patent, I surmised the last manual operation was to turn the end of the horseshoe inward.

Burden's later patents were improvements on the basic 1835 process. The 1843 patent (no. 3,261) combined the operation of the first two machines, eliminating one heating of the rod, but his 1857 and 1862 patents (nos. 17,665 and 35,746) combined all of the processes into one machine, representing a revolutionary increase in speed and efficiency. The 1865 patent was a reissue of the 1857 patent.

The improved 1857 machine formed two complete horseshoes for each revolution of the main wheel. Wrought-iron stock, 40 ft. in length, was discharged directly from the rolling mill without reheating. A handle activated the feeding of the rods, at the correct time, into the machine by a retracting roller mechanism. A rod of insufficient length entering the machine could cause a major breakage so a self-acting feed stop was incorporated. As one piece of stock was cut off, another was being grooved and punched. During rotary swaging, the horseshoe took the form of the large main wheel. To remove the swaged horseshoes, a V-shaped scraper was utilized in close contact with the outside diameter of the main wheel and dies. The last operation was for a cam-activated press to flatten the horseshoes before they went onto a conveyor belt to be packed in kegs. Judging from an early print, a coolant was used, probably a light spray of water. The machine reportedly was capable of making a horseshoe from a bar of iron in four seconds.

Using patent drawings as a guide, I built working models of two of the 1835 machines and the 1857 machine. The models help to visualize how Burden made the horseshoes. It is also interesting to see the progression of the design and improvements. The models are manually operated and not to scale; the only dimension I could reference in the 1835 patent application was that the flywheel was 4-ft. diameter. The ratio and pitch diameters of the gears dictated the size of the models.

The machine frame and journals are constructed of wood and cannot take the stress of forming the steel stock, which I found out the hard way using 1/8-in. square stock at red heat. I had trouble maintaining the heat and that led to machine breakage and forming problems. I reduced the stress using solder as the horseshoe material. The first time I turned a horseshoe I was surprised. I didn't think the swages would form a perfect U because the stock would creep in the middle, but I turned out a horseshoe approximately the size of a quarter.

The second machine, for grooving, nail punching, and

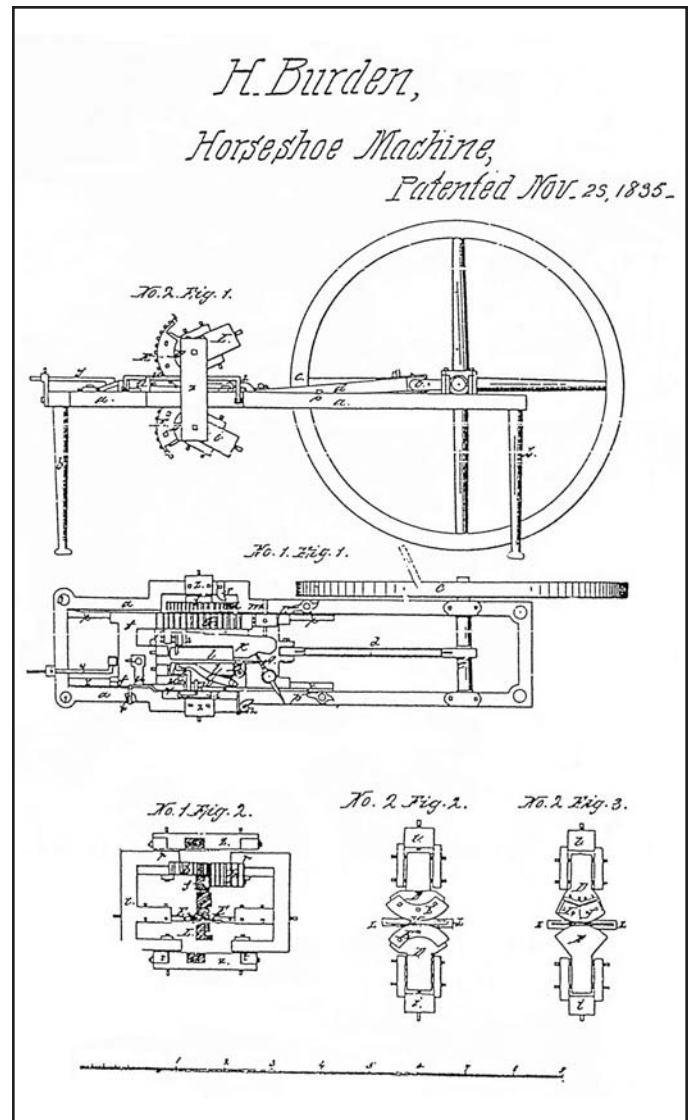

Burden's 1835 Patent.

cutoff, was much more difficult. I understood the basic principle of how it functioned, but could not visualize the exact method of operation. I enlarged the prints and color-coded them, but was at a loss for the overall machine design and construction. Burden's 150-yr.-old descriptions don't use the same terminology that a machinist would use today. For instance, sometimes Burden used the term "length" as we would use "diameter." Once I identified this particular problem it was easier to understand the patent application.

I've spent hundreds of hours working on the patent applications and horseshoe-machine models. There were always problems to be solved, and I have often thought about the ways Burden might have solved the same problem. After resolving one difficult model component, I looked at it and thought, "I know this is how Henry would have done it" —mechanically it was the best answer.

Robert C. Rawls

CHAPTER NEWS

Northern Ohio held its annual meeting in December with a slide-illustrated presentation from Steve Gordon of the Ohio Historic Preservation Office on the topic of nominating industrial properties to the National Register. The chapter met in April to hear David Brown give a talk on his new book, *White Hurricane: A Great Lakes November Gale*, that describes the effects of the storm of 1913.

Northern New England held its fall tour and annual meeting in Henniker, NH, on the theme of the wood-products industry. Stops included the Henniker Historical Society to view some of the woodworking tools and assorted items like wooden toys, followed by the Goss sawmill (est. 1938) with its logyard, dry kiln, and planing and finishing shop. Following an inspection of two riveted, Pratt, through-truss bridges (1915, 1933) over the Contoocook River, the chapter members toured Merrimac Log Homes (est. 2001), which shapes logs to sell directly to customers who build their own log houses. The day ended at the Hopkinton Dam (1962) with a tour of its gatehouse.

Oliver Evans (Philadelphia) members toured Kaolin Mushroom Farms in Kennett Square, PA, in March. Kaolin President Mike Pia led the tour and explained the state-of-the-art, soil-composting procedures, growing sheds, harvesting and picking, and packing and shipping operations. It was a more comprehensive tour than there had been time to offer during the 2005 SIA Fall Tour—Wilmington. Processing includes cleaning, sizing, and slicing the mushrooms according to the requirements of the buyers. The family-owned company processes only fresh mushrooms that are sold locally and in distant points such as New Orleans and Dallas.

Samuel Knight (Northern CA) members gathered for a daytrip via the Amtrak Capitol Corridor train (San Jose-Sacramento) earlier this spring. The layover in Sacramento provided an opportunity to tour the California State RR Museum (host—1996 SIA Annual Conference). In May, the chapter visited the Bale Grist Mill State Historic Park near St. Helena.

Southern New England was this year's host for the 18th Annual Conference on New England IA (the Southern and Northern NE chapters alternate). The conference was held at the Higgins Armory in Worcester, MA, Feb. 19, and featured a full slate of presentations, including the Noble & Cooley Drum Shop by Joyce Jones, Alexander Parris engineering projects by Sara Wermiel, Somerville Electric Light Co. by Gil Cooke, New Palmer iron works by James Johnson, the Air Line RR by Max Miller, the Dartmouth St. Building by Mark McGivern and Clark Griffith, and hazardous material archeology by Susan Cherau. The paper sessions were followed by a guided tour of the conservation workshop and armory led by William MacMillen.

Wabash & Ohio (Indiana and southern Ohio) is pleased to announce its reformation! The recent article in *SIAN* (Winter 2005) by Lynn Rakos, the SIA board local chapters committee chair, inspired chapter members to meet the challenge. They gathered in mid-April for a meeting at the new Wabash & Erie Canal Park in Delphi, IN (www.wabashanderiecanal.org). The chapter has registered the domain name *wosia.org* and hopes to have a Web site soon. Chapter contact: Bob Bernacki, bhb@bernacki.com until the Web site is available. ■

E.V. Logunov 1960-2004

Dr. E. V. Logunov, a prominent independent scholar of Russian industrial history and a guest of the SIA at its 2002 Annual Conference (Brooklyn), was murdered at his home in Sverdlovsk, Russia, on Dec. 26, 2004. Logunov was a graduate of the Kemerovo State University where he studied the history of the Siberian oil and gas complex. Later, he actively researched the industrial heritage of the Urals, publishing a number of papers and advocating the preservation of significant industrial sites. In the course of time, he showed himself to be a hard-working and persistent scholar, wielding a skillful pen, working hard in the archives, and demonstrating the best qualities of a researcher—careful investigation of sources, precise interpretation, and a broad view of the problem under study. Travelling extensively over western Siberia, he collected archival documents and office papers of business and construction organizations, as well as statistics. He frequently presented his research and conclusions at international conferences in Great Britain, Spain, Canada, the U.S., and Italy.

He was known to several SIA members through participation in The International Committee for the Conservation of the Industrial Heritage (TICCIH). As vice-president of the Association for the Conservation of the Industrial Heritage—a Russian national representative body of TICCIH—Logunov served on TICCIH's board and helped international scholars establish connections and cooperation with museums, local governments, and administrative bodies in Russia.

Stuart Smith, TICCIH Secretary

Rodney Swain 1921-2005

Rodney Swain was a member of the Southern New England Chapter, the Roebing Chapter, and a frequent presence at national SIA events and international study tours. A resident of Darien, CT, since 1956, Rodney was a graduate of the University of Rochester (BS) and the Polytechnic Institute of Brooklyn (MS) in chemical engineering. He worked at American Cynamid from 1943 to 1959 where he was initially involved in developing materials for the

(continued on page 17)

IA EXHIBITS

Folk Pottery Museum of Northeast Georgia. A new museum in Helen, GA, is scheduled to open later this year with a display of more than 150 pieces of utilitarian and decorative pottery highlighting the achievements of southern folk potters from the 1840s to today. Among the most prized artifacts are the “face jugs” with grotesque faces meant to keep children away from the liquor traditionally stored in them. The museum’s 3,200-sq.-ft. exhibit space was inspired by a potter’s workshop. Along with the main exhibit there will be a smokehouse, springhouse, and moonshine still on display to assist in telling the story of the work and culture of the region’s potters. Since the early 19th c., northeast Georgia has been an active pottery center because of its natural deposits of high-quality clay.—*The Gainesville (GA) Times* (Mar. 20, 2005).

Suspended in Time: Bridge Models from the Smithsonian Institution. Many SIA members remember the excellent collection of bridge models from the National Museum of American History’s Hall of Civil Engineers. They were taken off exhibit in late 2001 to make way for a new exhibit on the history of transportation (*America on the Move*). Some members took the opportunity for what they thought might be one last look at the 2001 Annual Conference—Washington, D.C. Now, fortunately, thanks to Lance Metz {SIA} and others, they have found a new location and are on display again in the upper gallery of the National Canal Museum, 30 Centre Sq., Easton, PA. Info: 610-515-8000.

Centuries of Progress: American World’s Fairs, 1853 to 1982. The exhibit, running through Dec. 31 at the Hagley Museum & Library (Wilmington, DE), takes a comprehensive look at the phenomenon of world’s fairs through the photographs, manuscripts, books, artifacts, and souvenirs from the more than 100 fairs represented in Hagley’s collections. Topics covered by the exhibit include the role world’s fairs played in the introduction and celebration of inventions and manufacturing technology, the popularization of consumer goods and foods (e.g., popcorn and ice cream sodas), and impact on design and taste. Info: www.hagley.org; 302-658-2400. ■

Rodney Swain (continued from page 16)

Manhattan Project. In the 1950s, Rodney helped develop the process to make Creslan fiber, the first synthetic fiber that could be mixed with wool and dyed to a uniform color. In 1959, he became a process engineer for Crawford & Russell of Stamford, CT. His work included participation in the design, construction, and startup of many plastics plants in the U.S. and abroad. After retiring in the late 1980s, Rodney developed a business as a woodturner. Working out of his basement, he made salad bowls, flower vases, earring stands, and cheese platters, which he sold at craft fairs and through local shops. He is survived by his wife Florence, also an SIA member, and two sons and a daughter.

IA ON THE WEB

Cornell University Library Collections (cdl.library.cornell.edu) has digitized a number of resources with IA content. The Ezra Cornell papers offer insight into the construction and operation of the telegraph industry. The Kinematics collection is a series of models and related materials that were used to train mechanical engineers in the design and operation of machine elements in the late 19th c. The Making of America collection allows users to search through more than 10,000 journal articles documenting technological and social history from the 1810s to 1870s.

Floyd Bennet Field (www.cr.nps.gov/nr/twhp/index.htm). A classroom-ready lesson plan uses the airfield’s history to teach about the role of naval aviators and women workers during WWII (tour site—2002 Annual Conference, Brooklyn).

From Sea to Shining Sea (www.nps.gov/pub_aff/maritime/celebrate.htm). The maritime history of the U.S. is the subject of this site developed by the National Park Service and the Naval Historical Center. It brings together information from several Web sites.

Historic Roads in Australia (www.corrugations.net.au). Conference will explore a range of themes and issues related to preserving historic roads in Australia and abroad.

Images of Labor (www.laborarts.org). “Virtual museum” offers an expansive collection of photos, posters, buttons, brochures, banners, paintings, sculpture, and other forms of art depicting work and workers past and present.

Furnaces (www.oldindustry.org). John Markiel has undertaken the daunting task of photo-documenting pre-1900 iron furnace sites throughout the U.S. Includes photos and a brief report on each site.

King’s Views of Philadelphia (www.brynmawr.edu/iconog/king/list2.html). More than 50 images of factories, warehouses, shipyards, and office buildings, c.1900.

Making Clay Roof Tiles (www.preservela.com/archives/2005_01.html). Making tiles by hand in Mexico with video clip and still photos.

National Cash Register’s Lantern Slides (www.daytonhistory.org/magiclantern.htm). The slides, which were made by printing a photographic image on glass for projection, were a favorite education and marketing tool of NCR founder John H. Patterson beginning in the 1890s. He used them to illustrate the manufacture and uses of cash registers, and to illustrate lectures on public health, history, urban reform, worker welfare, the art of window display, business systems, and world travel. A selection of the more than 68,000 slides in the collection has been digitized.

New York Labor History Assn. (www.ilr.cornell.edu/nylha/index.htm). Conferences, exhibits, films, and walking tours with a focus on the history of workers and their organizations in NY.

(continued on page 18)

NOTES & QUERIES

Granite Panels Found. The mystery location of the architectural friezes depicting construction trades (*SIAN*, Spring-Summer 2004) has been solved. Marilyn Day of the Westford (MA) Historic Society, who was leading the search, reports that the friezes are located over the north and east entrances of the North Office Building (1927) of the capitol complex in Harrisburg, PA. The families of the workers who made the panels at the Fletcher Granite Co. in Chelmsford, MA, are elated to have found the panels, and they send their thanks to SIA members who helped provide the leads that eventually located them.

Bridges on Euros. Some SIA members may have noticed the bridges engraved on various Euro notes (denominations of 5, 10, 20, 50, 200, and 500). The bridges were the Europeans' answer to the design of a single currency for 12 nations with jealously guarded identities. It was decided that the notes could not feature the portraits of historical figures or designs attributed to any single country. The bridges, therefore, signify seven periods of European architecture—Classical, Romanesque, Gothic, Renaissance, Baroque, Iron, and Modern—with the bridge symbolizing communication among people of Europe. The thing is, these are not real bridges. The designer, Robert Kalina, an engraver at the Austrian National Bank, scanned pictures from art-history books, and then using imaging software, took different parts of different bridges and created virtual designs.

Call for Papers. The **Business History Conference** will hold its annual meeting June 8-10, 2006, at the Munk Centre for International Studies of the University of Toronto, Canada. The theme is *Political Economy of Enterprise*. Business, the political system, and government have influenced one another from time immemorial. This year's program committee invites scholars to reflect on those interactions, with a special emphasis on Canadian business history. Potential presenters may submit proposals either for individual papers or for panels. Individual paper proposals should include a one-page abstract and a one-page *cv*. The abstract should summarize the argument of the paper, the sources on which it is based, and its relationship to existing scholarship. Each panel should include a cover letter stating the rationale for the session, a one-page abstract and *cv* for each proposed paper (up to three), and a list of preferred chairs and commentators with contact information. Proposal deadline: Oct. 15. Info: Roger Horowitz, BHC, Box 3630, Wilmington, DE 19807; (302) 658-2400; rh@udel.edu; www.thebhc.org.

National Preservation Institute, a nonprofit organization, offers a regular series of courses and workshops for persons involved in the management, preservation, and stewardship of historic properties of all types. Recent courses with potential application to IA include historic structures reports, field conservation for archeologists, evaluation of mid-20th-c. buildings, historic landscapes, cemetery preser-

vation, and federal preservation laws and regulations such as Section 106. Courses are offered throughout the year and in all regions of the U.S. Info: www.npi.org.

The **National Canal Museum** (Easton, PA) recently received a donation of **Panama Canal** documents and printed materials. These government documents and reports relate to the design, construction, and administration of the canal. Historian Lee Maddex [SIA] of Morgantown, WV, donated the collection to the museum in January. The collection includes engineering and administrative reports covering the canal's construction, operation, and governance throughout much of the 20th c. Once the collection has been inventoried, it will be made available to scholars and students. A copy of the inventory will also be available on the museum's Web site, www.canals.org.

Home Wanted for Historic Cotton Press. A 1916 Webb Press Co. cotton press, originally purchased by the Port of New Orleans and rescued from the Napoleon St. Wharf in 2000 (see *SIAN*, Winter 2003), is currently disassembled and stored in an industrial yard in New Orleans. The group that rescued the press is hoping to find an individual or organization willing to take possession of the press for its long-term preservation. The press is a substantial piece of machinery standing 3-stories tall. It was capable of exerting 4-million lbs. of uniform pressure to form 500-lb. bails of cotton. Info: Jim Stoyanoff, (504) 523-1831. ■

IA ON THE WEB (continued from page 17)

Ohio Bridges (home.insight.rr.com/ronalexaura). On-line list of the state's historic bridges and their current status by a local bridge enthusiast. Includes links to local history, HAER, ODOT, and other sites for additional info on specific bridges.

Point Reyes Lighthouse (www.nps.gov/pore/history_maritime_lighthouse.htm). History and recent efforts to restore the lamp of the 1870 California lighthouse.

Route der Industriekultur (www.route-industriekultur.de/steuer/menue/menue_e.htm) is the German heritage tourism initiative to promote the preservation of the industrial heritage of the Ruhr Valley. This English-language version of the Web site is a great way to become acquainted with it for those members who didn't go there on the SIA study tour (*SIAN*, Spring 2001).

Wilbur and Ruth Watson Bridge Book Collection (www.clevelandmemory.org/watson) at Cleveland State University includes an extensive album of photos of historic bridges from around the world, as well as digitized books on Cleveland's bridges. Wilbur Watson was a bridge engineer, and his daughter, Ruth, taught a course on the history of civil engineering at Fenn College.

San Diego Harbor Defenses, 1796-1947 (www.cr.nps/history/park_histories/index.htm), one of the latest offerings of the National Park Service's history books online. ■

SITES & STRUCTURES

Colorado's Most Endangered Historic Places list for 2005 includes several sites of IA interest. **Hangar 61** within the former Stapleton International Airport Complex is a thin-shell, reinforced-concrete arched structure, built in 1959 to a design by engineer Milo Ketchum. The hangar is under threat of demolition unless a workable alternative for adaptive re-use is found. The towns of **Georgetown, Silver Plume, and Idaho Springs** attest to the Rocky Mountains' history of mining, milling, lumbering, and railroading. All are recognized as National Register historic districts, but controversy is brewing because of plans to widen I 70 from four to six lanes, potentially introducing increased noise, air, and water pollution. The **Union Pacific Pumphouse** (c.1870) in Kit Carson pumped water to supply the railroad's steam locomotives. The local historical society is attempting to raise funds to repair the severely deteriorated building, but the railroad has plans to demolish it if the society does not begin the costly work soon. Info: www.coloradopreservation.org.

Georgia's **Augusta Canal** is undergoing restoration, including dredging and reconstruction of the timber headgates, as part of the ongoing development of the Augusta Canal National Heritage Area. The canal, built in 1845 and enlarged in 1875, bypassed rapids in the Savannah River and was used for both transportation and waterpower. The Canal Authority is now offering guided boat tours of the canal, beginning at the visitors center in the restored Enterprise Mill. The boats will be able to move between the river and the canal upon completion of the headgates. The boats are patterned after the shallow-bottom boats that historically delivered cotton from upriver plantations to Augusta's mills.

Portal 31 Coal Mine in Lynch, KY, opened in 1920 and shut down nearly 30 years ago, but now it is being promoted as a "Disney-like" tourist attraction under a plan developed by the Kentucky Dept. of Parks. Visitors will learn the history of mining technology on a 30-minute, underground ride featuring animatronic miners. The mine is scheduled to open to tours later this year and will be operated as part of the Kingdomcome State Park (with RV campground next to the mine!). The project is part of on-going efforts to promote tourism to the Cumberlands region. Info: www.kingdomcome.org/portal/index.html. ■

Antique Power Show *(continued from page 5)*

Park Grounds, Sept. 10-11. Info: www.hcrhp.org. In conjunction with the Stumptown Steam Threshers Show & Reunion.

Hemlock, OH. Little Cities of Black Diamonds Day, Southern Local Schools Campus, Oct. 16. Info: www.littlecitiesofblackdiamonds.org. Celebrates the heritage of a series of coal mining boomtowns founded from 1870-1920. ■



Glenn Rittenger

The Milford (MI) Historical Society and Downtown Development Authority have begun restoration of the Pettibone Creek Hydroelectric Station, the Albert Kahn-designed, Art Deco-style, powerhouse built by the Ford Motor Co. in 1939 (SIAN, Spring 2002). The powerhouse supplied power to one of Ford's "village industries" that produced supplies and parts for the main production line at the River Rouge Plant in Detroit. With removal of 80 percent of the exterior brick, the restoration has temporarily turned the beautiful building into a skeleton resembling a winged giant. The exterior restoration has a price tag of \$400,000 and will set the stage for interior restoration and historic interpretation. Funding for the project has been raised from a large number of sources.

NEWS OF MEMBERS

Bob Bernacki, former president and a founder of the Wabash & Ohio SIA chapter, has been active as a consulting party for the study of the I-69 corridor through southwest Indiana. Efforts have been made to ensure that a 19th-c. ironworks and 20th-c. limestone mills are given due consideration during Section 106 review to ensure that the highway does not result in unnecessary damage to or demolition of the historic sites. Other preservation efforts have included the monitoring of the remaining early beehive-oven brickworks in Indiana. One of Bob's additional projects has included the videography of the closing of iron foundries in Indiana, sadly due to price pressures on these old industries from foreign competition. ■

CALENDAR

2005

July 5-9: National Railway Historical Society Annual Convention, Portland, OR. Rail excursions and speakers on restored steam operation. Info: www.nrhs2005.com.

July 6-8: TICCIH Intermediate Conference & International Forum for Industrial Tourism, Nagoya Aichi, Japan. Paper sessions and tours to area museums and industries (canals, water systems, porcelain). Info: www.congre.co.jp/TICCIH.ifitjapan2005.

July 16: Franconia Iron Furnace 200th Anniversary Celebration, Franconia, NH. Speakers and demonstrations. See article in this issue. Info: Jewell Friedman, 603-823-5951; dwjaf@ncia.net.

Sept. 29-Oct. 2: SIA Fall Tour, Detroit, MI. Tours of industries and museums. See article in this issue. Info: events@siahq.org; www.sia-web.org.

Oct. 5-9: Assn. of Railway Museums Conference, Strasburg, PA. Hosted by the RR Museum of PA. Info: www.rrmuseumpa.org.

Oct. 6-9: International Conference on the History of Transport, Traffic and Mobility, National Railway Museum, York, U.K. Info: www.t2m.org.

Oct. 14-16: Historic Ironmaking Conference (Ironmasters Conference), Sterling Forest State Park, Tuxedo, NY. Paper proposals requested. See article in this issue. Info: Edward J. Lenik, 100 Deerfield Rd., Wayne, NJ 07470; edlenik@hotmail.com.

Oct. 20-22: Annual North American Labor History Conference, Wayne State Univ., Detroit, MI. Topic: Labor, Solidarity, and Organizations with an emphasis on the IWW. Info: Janine Lanza, Dept. of History, 3094 Faculty Admin. Bldg., WSU, Detroit, MI 48202; 313-577-2525; ao1605@wayne.edu; www.cla.wayne.edu/history/conf-cal/nalh.c.

Oct. 27-29: Pioneer America Society Annual Conference, Baton Rouge, LA. Theme: Changing Landscapes of the Lower Mississippi Valley. Tours of French and Arcadian vernacular architecture, and of the human transformation of the valley's environment, including engineering of the Mississippi River. Paper proposals requested. Info: www.pioneeramerica.org.

Nov. 3-6: Society for the History of Technology Annual Meeting, Minneapolis, MN. Info: www.shot.jhu.edu.

Nov. 20-26: SIA Study Tour to Bologna, Italy. See article in this issue. Info: Mary Habstritt, SIA Events Coordinator; events@siahq.org; 212-769-4946.

2006

Mar. 29-Apr. 2: Second International Congress on Construction History, Queens' College, University of Cambridge, U.K. Info: www.chs-cambridge.co.uk.

June 8-10: Business History Conference Annual Meeting, Toronto, ON. See article in this issue. Info: BHC, Box 3630, Wilmington, DE 19807; www.thebhc.org.

Department of Social Sciences
Michigan Technological University
1400 Townsend Drive
Houghton MI 49931-1295

**SOCIETY FOR
INDUSTRIAL
ARCHEOLOGY**

Address Service Requested

Presorted Standard Mail
U.S. POSTAGE
PAID
Permit No. 2431
Minneapolis, MN